

# Data Sheet

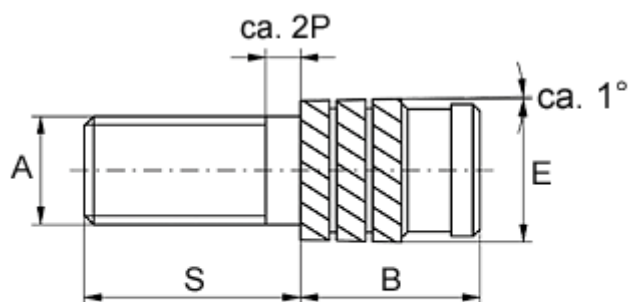

Article number: 12856000050840  
Description: KLEE-coil 856 000 050.840  
M5 Brass

## Measures



Gevindlængde =  $S - 2P$   
P = stigning

Male thread A	= M5x0,8
Min distance to edge	= 2.5
Mounting length B	= 8.3
Outer diameter E	= 6.60
Pin length S	= 10
Recommended bore diameter	= 6.2
Type	= 856 000 050.840